

8STA Series PC Tail Contacts



Connectors for Electronic Box Applications

In addition to 8STA connectors with PCB contacts #22D, SOURIAU now offer connectors with PCB contacts #16, #20 and #26.

30 layouts available ■ Provides maximum flexibility according to application.

Specific PC tail length ■ Simplifies daughter board positioning.
For contacts #22D and #20:

- Standard = 3.5mm
- Specific = 4.6 or 8.5mm

Available with clinch nuts ■ Faster installation.

Description

- Rugged aluminium body to ensure long service life in the harshest environment
- 8STA PCB connectors are available in shell sizes 02 to 24 (12 sizes)
- 100% scoop proof
- Available with clinch nut
- 6 colour coded keyway orientations



Technical features

Mechanical

- **Shell:** Aluminium
- **Shell plating:** Conductive black zinc
- **Insulator:** Liquid silicone rubber
- **Seal:** Liquid silicone rubber
- **Contact:** Copper alloy
- **Contact plating:** Gold
- **Endurance:** 500 matings/unmatings
- **Shock:** 300g for 3ms and EIA-364-27
- **Vibration:** 147m/s², 10 to 2000 Hz

Electrical

- **Contact resistance:**
 - Size 26: 16 mΩ
 - Size 22D: 14.6 mΩ
 - Size 20: 7.3 mΩ
 - Size 16: 3.8 mΩ
- **Insulation resistance:**
 - ≥ 5000MΩ (at 500Vdc)
- **Contact rating:**
 - Size 26: 3 Amp
 - Size 22D: 5 Amp
 - Size 20: 7.5 Amp
 - Size 16: 13 Amp
- **Shell continuity:** ≤ 10mΩ

Environmental

- **Temperature range:** -55°C to +175°C
- **Sealing mated connectors:**
 - IP67 (1 metre for 30 min minimum)
- **Salt spray:** 48 hours

Ordering information

Basic series	8STA	2	12	35	P	N	-
Shell type: 2: Oval flange receptacle with PCB contacts							
Shell size: 02, 04, 06, 08, 10, 12, 14, 16, 18, 20, 22, 24							
Contact layout: See pages 05 to 10							
Type of contact: P: Pin S: Socket							
Orientation: N: Red, A: Yellow, B: Blue, C: Orange, D: Green, E: Grey (shell size 02 only)							
Specification : None: Standard version 499: Integrated clinch nut on flange (M2 for sizes 02, 04 & 06; M3 for sizes 08 to 24) 528: Integrated clinch nut on flange (M2.5 for sizes 02, 04 & 06) 571: Specific PC tail (length = 4.6mm) - only available for sizes 08 to 24 (see next page) 625: Specific PC tail (length = 8.5mm) - only available for sizes 08 to 24 (see next page)							

Dimensions

Shell sizes 02, 04 & 06

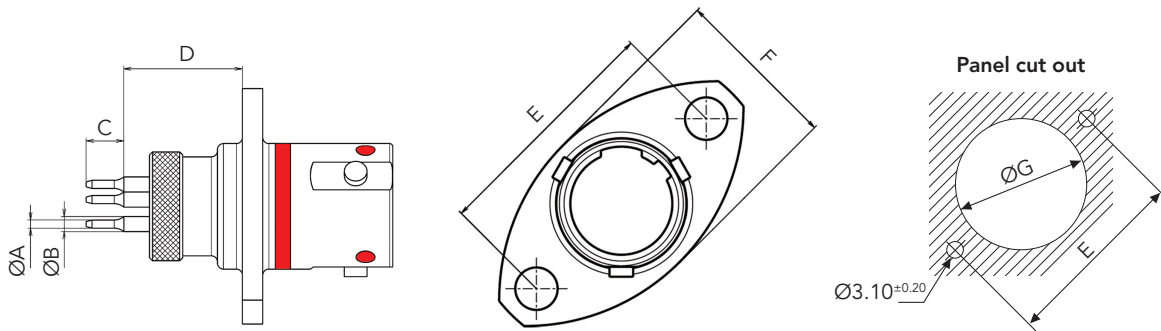

Contact size	ØA Max	ØB Max
#22D	0.70	1.25
#26	0.55	1.16

Shell size	C Max	D max	E	F Max	ØG
02	2.5	9.5	15.3 ^{±0.2}	10.7	9.3 ^{±0.1}
04	2.5	8.7	16.2 ^{±0.2}	13.2	12.0 ^{±0.1}
06	4.1	14.7	18.0 ^{±0.2}	14.8	13.0 ^{±0.1}

Note: All dimensions are in millimeters (mm)

Shell sizes 08 to 24

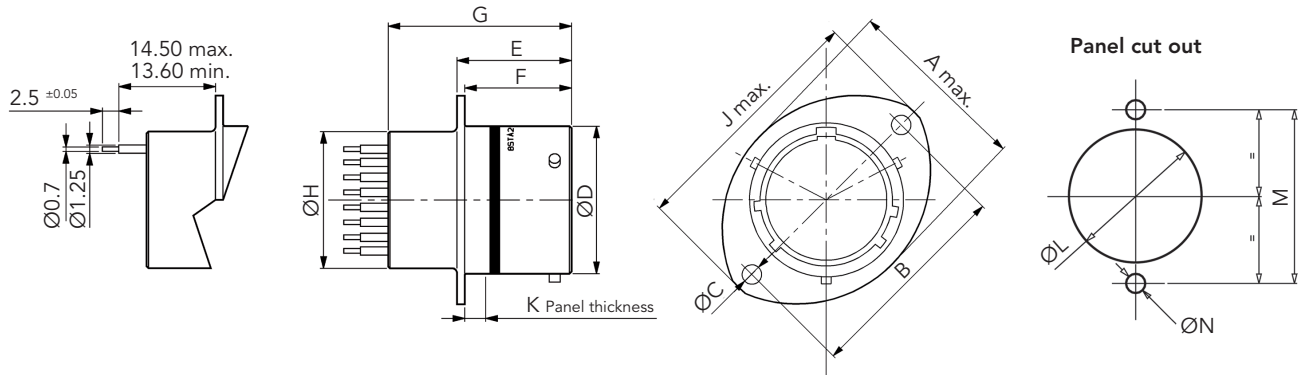

Shell size	A Max	B ^{±0.20}	ØC	ØD ^{+0.2}	E	F	G Max	ØH Max	J Max	K Max	ØL ^{±0.10}	M ^{±0.20}	ØN ^{±0.20}
08	16.50	21.40	3.20	12.00	17.21	16.05	27.65	11.10	27.20	3.00	14.50	21.40	3.60
10	19.50	25.90		14.97				13.90	32.00		17.40	25.90	
12	24.00	29.10		19.05				17.35	35.20		21.90	29.10	
14	26.90	32.50		22.22				20.50	38.40		25.00	32.50	
16	30.30	34.80		25.40				23.70	41.00		28.20	34.80	
18	33.70	38.20		28.57				26.91	44.70		31.40	38.20	
20	37.00	41.60		31.77				30.11	47.80		34.60	41.60	
22	40.40	45.00	34.90	33.20	51.00	37.60	45.00						
24	43.40	49.50	3.77	38.10	18.20	15.29	36.40	55.80	41.00	49.50	4.10		

Specific PC Tail version

Available with layouts using contacts #22D and/or #20

Also available with clinch nut: please consult us

Specification 571: PC tail length = 4.6 mm

Specification 625: PC tail length = 8.5 mm

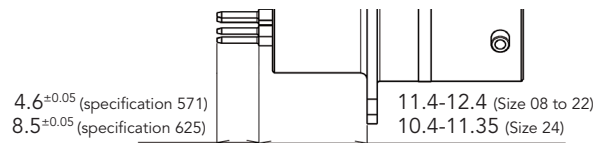

Note: All dimensions are in millimeters (mm)

PCB drilling information

Viewed from front face of male insulator.

02

05

Ctc	X	Y
1	0.00	1.45
2	1.38	0.45
3	0.85	-1.18
4	-0.85	-1.18
5	-1.38	0.45

35

Ctc	X	Y
A	0.00	1.30
B	1.13	-0.65
C	-1.13	-0.65

04

05

Ctc	X	Y
A	1.14	1.57
B	1.84	-0.60
C	0.00	-1.94
D	-1.84	-0.60
E	-1.14	-1.57

35

Ctc	X	Y
A	1.24	0.72
B	0.00	-1.43
C	-1.24	0.72

08

35

Ctc	X	Y
1	+1.14	+1.98
2	+1.98	-1.14
3	0.00	-2.29
4	-1.98	-1.14
5	-1.14	+1.98
6	0.00	0.00

98

Ctc	X	Y
A	+1.65	+0.97
B	0.00	-1.90
C	-1.65	+0.97

10

35

Ctc	X	Y
1	0.00	+3.71
2	+2.16	+3.00
3	+3.51	+1.14
4	+3.51	-1.14
5	+2.16	-3.00
6	0.00	-3.71
7	-2.16	-3.00
8	-3.51	-1.14
9	-3.51	+1.14
10	-2.16	+3.00
11	0	+1.42
12	+1.24	-0.89
13	-1.24	-0.89

98

Ctc	X	Y
A	0.00	+3.30
B	+3.30	0.00
C	+1.65	-2.87
D	-1.65	-2.87
E	-3.30	0.00
F	0.00	0.00

99

Ctc	X	Y
A	+1.65	+2.85
B	+3.30	0.00
C	+1.65	-2.87
D	-1.65	-2.87
E	-3.30	0.00
F	-1.65	+2.87
G	0.00	0.00

12

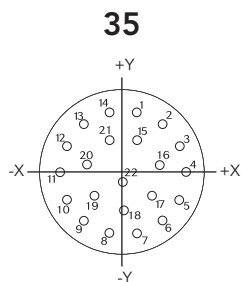

Ctc	X	Y	Ctc	X	Y
1	+1.14	+5.00	12	-4.62	+2.24
2	+3.20	+4.01	13	-3.20	+4.01
3	+4.62	+2.24	14	-1.14	+5.00
4	+5.16	0.00	15	+1.14	+2.72
5	+4.62	-2.24	16	+2.97	+0.66
6	+3.20	-4.01	17	+2.36	-1.91
7	+1.14	-5.00	18	0.00	-3.05
8	-1.14	-5.00	19	-2.36	-1.91
9	-3.20	-4.01	20	-2.97	+0.66
10	-4.62	-2.24	21	-1.14	+2.72
11	-5.16	0.00	22	0.00	-0.76

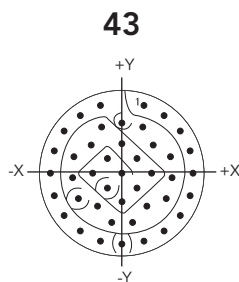

Ctc	X	Y	Ctc	X	Y	Ctc	X	Y
1	+1.80	+5.54	16	-5.54	+1.80	30	-3.57	-2.06
2	+3.42	+4.71	17	-4.71	+3.42	31	-4.10	-0.43
3	+4.71	+3.42	18	-3.42	+4.71	32	-3.92	+1.27
4	+5.54	+1.80	19	-1.80	+5.54	33	-2.54	+2.28
5	+5.82	0.00	20	0.00	+4.12	34	-1.68	+3.76
6	+5.54	-1.80	21	+1.68	+3.76	35	0.00	+2.42
7	+4.71	-3.42	22	+2.54	+2.28	36	+1.21	+1.21
8	+3.42	-4.71	23	+3.92	+1.27	37	+2.42	0.00
9	+1.80	-5.54	24	+4.10	-0.43	38	+1.21	-1.21
10	0.00	-5.82	25	+3.57	-2.06	39	0.00	-2.42
11	-1.80	-5.54	26	+1.99	-2.74	40	-1.21	-1.21
12	-3.42	-4.71	27	+0.86	-4.03	41	-2.42	0.00
13	-4.71	-3.42	28	-0.86	-4.03	42	-1.21	+1.21
14	-5.54	-1.80	29	-1.99	-2.74	43	0.00	0.00
15	-5.82	0.00						

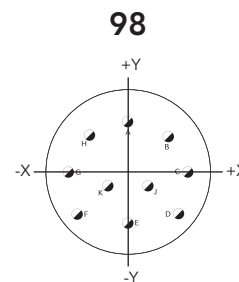

Ctc	X	Y	Ctc	X	Y
A	0.00	+4.95	F	-4.17	-2.67
B	+3.18	+3.81	G	-4.90	+0.76
C	+4.90	+0.76	H	-3.18	+3.81
D	+4.17	-2.67	J	+1.65	-0.38
E	0.00	-3.43	K	-1.65	-0.38

14

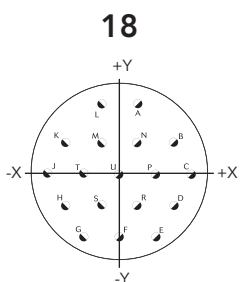

Ctc	X	Y	Ctc	X	Y
A	+1.65	+6.40	K	-4.95	+2.87
B	+4.95	+2.87	L	-1.65	+6.40
C	+6.60	0.00	M	-1.65	+2.87
D	+4.95	-2.87	N	+1.65	+2.87
E	+3.30	-5.72	P	+3.30	0.00
F	0.00	-5.72	R	+1.65	-2.87
G	-3.30	-5.72	S	-1.65	-2.87
H	-4.95	-2.87	T	-3.30	0.00
J	-6.60	0.00	U	0.00	0.00

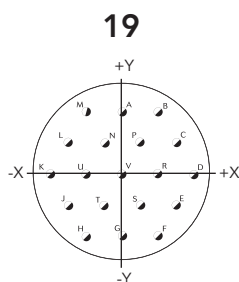

Ctc	X	Y	Ctc	X	Y
A	0.00	+5.72	L	-4.95	+2.87
B	+3.30	+5.72	M	-3.30	+5.72
C	+4.95	+2.87	N	-1.65	+2.87
D	+6.60	0.00	P	+1.65	+2.87
E	+4.95	-2.87	R	+3.30	0.00
F	+3.30	-5.72	S	+1.65	-2.87
G	0.00	-5.72	T	-1.65	-2.87
H	-3.30	-5.72	U	-3.30	0.00
J	-4.95	-2.87	V	0.00	0.00
K	-6.60	0.00			

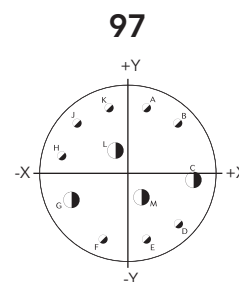

Ctc	X	Y	Ctc	X	Y
A	+1.65	+5.94	G	-5.26	-2.41
B	+4.52	+4.52	H	-5.94	+1.65
C	+5.84	-0.58	J	-4.52	+4.52
D	+4.52	-4.52	K	-1.65	+5.94
E	+1.65	-5.94	L	-1.19	+2.06
F	-2.26	-5.97	M	+1.19	-2.06

14

35

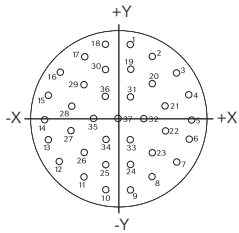

Ctc	X	Y
1	+1.14	+6.65
2	+3.12	+5.51
3	+5.36	+4.06
4	+6.45	+2.03
5	+6.76	-0.25
6	+6.27	-2.49
7	+5.08	-4.45
8	+3.30	-5.89
9	+1.14	-6.65
10	-1.14	-6.65
11	-3.30	-5.89
12	-5.08	-4.45
13	-6.27	-2.49
14	-6.76	-0.25
15	-6.45	+2.03
16	-5.36	+4.06
17	-3.12	+5.51
18	-1.14	+6.65
19	+1.14	+4.37
20	+3.12	+3.02
21	+4.32	+1.02
22	+4.32	-1.27
23	+3.12	-3.23
24	+1.14	-4.37
25	-1.14	-4.37
26	-3.12	-3.23
27	-4.32	-1.27
28	-4.32	+1.02
29	-3.12	+3.02
30	-1.14	+4.37
31	+1.14	+1.88
32	+2.29	-0.10
33	+1.14	-2.08
34	-1.14	-2.08
35	-2.29	-0.10
36	-1.14	+1.88
37	0.00	-0.10

16

08

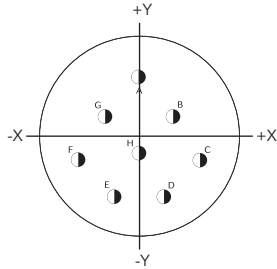

Ctc	X	Y
A	0.00	+5.99
B	+3.25	+2.18
C	+5.84	-1.98
D	+2.39	-5.49
E	-2.39	-5.49
F	-5.84	-1.98
G	-3.25	+2.18
H	0.00	-1.32

26

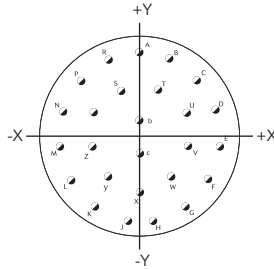

Ctc	X	Y
A	0.00	+8.15
B	+3.33	+7.44
C	+6.07	+5.44
D	+7.75	+2.51
E	+8.10	-0.86
F	+7.06	-4.09
G	+4.80	-6.60
H	+1.70	-7.98
J	-1.70	-7.98
K	-4.80	-6.60
L	-7.06	-4.09
M	-8.10	-0.86
N	-7.75	+2.51
P	-6.07	+5.44
R	-3.33	+7.44
S	-1.78	+4.50
T	+1.78	+4.50
U	+4.45	+2.39
V	+4.53	-0.91
W	+3.02	-3.84
X	0.00	-5.16
Y	-3.02	-3.84
Z	-4.53	-0.91
a	-4.45	+2.39
b	0.00	+1.65
c	0.00	-1.65

99

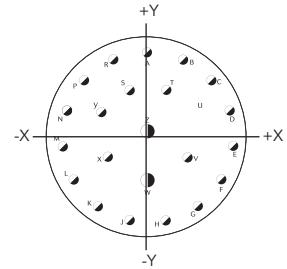

Ctc	X	Y
A	0.00	+8.15
B	+3.33	+7.44
C	+6.07	+5.44
D	+7.75	+2.51
E	+8.10	-0.86
F	+7.06	-4.09
G	+4.80	-6.60
H	+1.70	-7.98
J	-1.70	-7.98
K	-4.80	-6.60
L	-7.06	-4.09
M	-8.10	-0.86
N	-7.75	+2.51
P	-6.07	+5.44
R	-3.33	+7.44
S	-1.78	+4.50
T	+1.78	+4.50
U	+4.45	+2.39
V	+3.81	-1.91
W	0.00	-4.09
X	-3.81	-1.91
Y	-4.45	+2.39
Z	0.00	+0.64

35

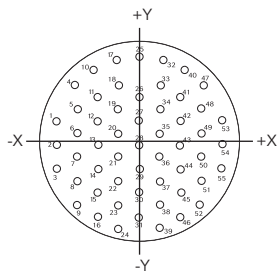

Ctc	X	Y
1	-7.92	+2.18
2	-7.92	-0.10
3	-7.92	-2.39
4	-6.15	+5.61
5	-5.94	+3.33
6	-5.94	+1.04
7	-5.94	-1.24
8	-5.94	-3.53
9	-5.94	-5.82
10	-4.37	+7.09
11	-3.96	+4.47
12	-3.96	+2.18
13	-3.96	-0.10
14	-3.96	-2.39
15	-3.96	-4.67
16	-3.96	-6.96
17	-2.26	+8.03
18	-1.98	+5.61
19	-1.98	+3.33
20	-1.98	+1.04
21	-1.98	-1.24
22	-1.98	-3.53
23	-1.98	-5.82
24	-1.98	-8.10
25	0.00	+8.36
26	0.00	+4.47
27	0.00	+2.18
28	0.00	-0.10
29	0.00	-2.39
30	0.00	+4.67
31	0.00	-6.96
32	+2.26	+8.03
33	+1.98	+5.61
34	+1.98	+3.33
35	+1.98	+1.04
36	+1.98	-1.24
37	+1.98	-3.53
38	+1.98	-5.82
39	+1.98	-8.10
40	+4.37	+7.09
41	+3.96	+4.47
42	+3.96	+2.18
43	+3.96	-0.10
44	+3.96	-2.39
45	+3.96	-4.67
46	+3.96	-6.96
47	+6.15	+5.61
48	+5.94	+3.33
49	+5.94	+1.04
50	+5.94	-1.24
51	+5.94	-3.53
52	+5.94	-5.82
53	+7.92	+2.18
54	+7.92	-0.10
55	+7.92	-2.39

18

32

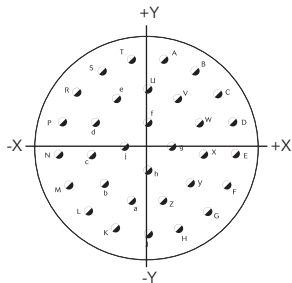

Ctc	X	Y	Ctc	X	Y	Ctc	X	Y
A	+1.68	+8.97	M	-8.15	-4.06	Z	+1.65	-5.61
B	+4.80	+7.75	N	-9.07	-0.84	a	-1.65	-5.61
C	+7.26	+5.51	P	-8.76	+2.49	b	-4.42	-3.84
D	+8.76	+2.49	R	-7.26	+5.51	c	-5.79	-0.84
E	+9.07	-0.84	S	-4.80	+7.75	d	-5.31	+2.41
F	+8.15	-4.06	T	-1.68	+8.97	e	-3.15	+4.90
G	+6.15	-6.73	U	0.00	+5.84	f	0.00	+2.44
H	+3.30	-8.51	V	+3.15	+4.90	g	+2.44	0.00
J	0.00	-9.12	W	+5.31	+2.41	h	0.00	-2.44
K	-3.30	-8.51	X	+5.79	-0.84	j	-2.44	0.00
L	-6.15	-6.73	Y	+4.42	-3.84			

35

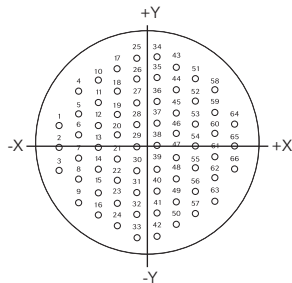

Ctc	X	Y	Ctc	X	Y	Ctc	X	Y
1	-9.07	+2.29	12	-5.11	+2.29	23	-3.12	-5.71
2	-9.07	0.00	13	-5.11	0.00	24	-3.12	-8.00
3	-9.07	-2.29	14	-5.11	-2.29	25	-1.14	+9.14
4	-7.09	+5.71	15	-5.11	-4.57	26	-1.14	+6.86
5	-7.09	+3.43	16	-5.11	-6.86	27	-1.14	+4.57
6	-7.09	+1.14	17	-3.12	+8.00	28	-1.14	+2.29
7	-7.09	-1.14	18	-3.12	+5.71	29	-1.14	0.00
8	-7.09	-3.43	19	-3.12	+3.43	30	-1.14	-2.29
9	-7.09	-5.71	20	-3.12	+1.14	31	-1.14	-4.57
10	-5.11	+6.86	21	-3.12	-1.14	32	-1.14	-6.86
11	-5.11	+4.57	22	-3.12	-3.43			

Ctc	X	Y	Ctc	X	Y
45	+3.12	+3.43			
46	+3.12	+1.14			
47	+3.12	-1.14			
48	+3.12	-3.43			
49	+3.12	-5.71			
50	+3.12	-8.00			
51	+5.11	+6.86			
52	+5.11	+4.57			
53	+5.11	+2.29			
54	+5.11	0.00			
55	+5.11	-2.29			
56	+5.11	-4.57			
57	+5.11	-6.86			
58	+7.09	+5.71			
59	+7.09	+3.43			
60	+7.09	+1.14			
61	+7.09	-1.14			
62	+7.09	-3.43			
63	+7.09	-5.71			
64	+9.07	+2.29			
65	+9.07	0.00			
66	+9.07	-2.29			

20

39

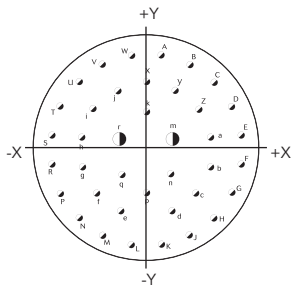

Ctc	X	Y	Ctc	X	Y	Ctc	X	Y
A	+1.65	+10.44	P	-9.42	-4.80	d	+2.84	-6.73
B	+4.80	+9.42	R	-10.44	-1.65	e	-2.84	-6.73
C	+7.47	+7.47	S	-10.44	+1.65	f	-5.51	-4.80
D	+9.42	+4.80	T	-9.42	+4.80	g	-7.11	-1.88
E	+10.44	+1.65	U	-7.47	+7.47	h	-7.11	+1.45
F	+10.44	-1.65	V	-4.80	+9.42	i	-5.89	+4.55
G	+9.42	-4.80	W	-1.65	+10.44	j	-3.20	+6.50
H	+7.47	-7.47	X	0.00	+7.49	k	0.00	+4.17
J	+4.80	-9.42	Y	+3.20	+6.50	m	+2.90	+1.22
K	+1.65	-10.44	Z	+5.89	+4.55	n	+2.69	-2.72
L	-1.65	-10.44	a	+7.11	+1.45	p	0.00	-4.80
M	-4.80	-9.42	b	+7.11	-1.88	q	-2.69	-2.72
N	-7.47	-7.47	c	+5.51	-4.80	r	-2.90	+1.22

35

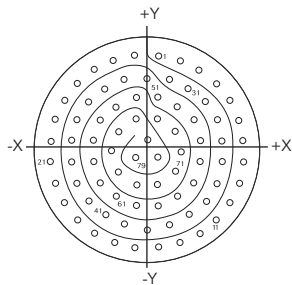

Ctc	X	Y	Ctc	X	Y	Ctc	X	Y
1	+1.35	+10.82	22	-10.85	+1.22	36	+7.90	-3.58
2	+3.71	+10.26	23	-10.31	+3.58	37	+6.55	-5.59
3	+5.89	+9.19	24	-9.27	+5.77	38	+4.67	-7.11
4	+7.77	+7.67	25	-7.77	+7.67	39	+2.49	-8.18
5	+9.27	+5.77	26	-5.89	+9.19	40	0.00	-8.81
6	+10.31	+3.58	27	-3.71	+10.26	41	-2.49	-8.18
7	+10.85	+1.22	28	-1.35	+10.82	42	-4.67	-7.11
8	+10.85	-1.22	29	0.00	+8.20	43	-6.55	-5.59
9	+10.31	-3.58	30	+2.49	+8.18	44	-7.90	-3.58
10	+9.27	-5.77	31	+4.67	+7.11	45	-8.43	-1.22
11	+7.77	-7.67	32	+6.55	+5.59	46	-8.43	+1.22
12	+5.89	-9.19	33	+7.90	+3.58	47	-7.90	+3.58
13	+3.71	-10.26	34	+8.43	+1.22	48	-6.55	+5.59
			35	+8.43	-1.22	49	-4.67	+7.11

Ctc	X	Y	Ctc	X	Y	Ctc	X	Y
58	+3.40	-5.05						
59	+1.22	-6.12						
60	-1.22	-6.12						
61	-3.40	-5.05						
62	-5.28	-3.53						
63	-6.02	-1.22						
64	-6.02	+1.22						
65	-5.28	+3.53						
66	-3.40	+5.05						
67	-1.22	+3.71						
68	+1.22	+3.71						
69	+3.18	+2.29						
70	+3.94	0.00						
71	+3.18	-2.29						
72	+1.22	-3.71						
73	-1.22	-3.71						
74	-3.18	-2.29						
75	-3.94	0.00						
76	-3.18	+2.29						
77	0.00	+1.35						
78	+1.22	-0.74						
79	-1.22	-0.74						

20

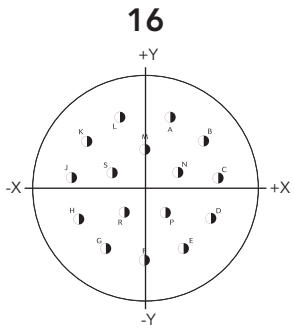

Ctc	X	Y
A	+3.00	+8.18
B	+6.88	+5.36
C	+8.66	+0.91

Ctc	X	Y
D	+7.82	-3.81
E	+4.62	-7.37
F	0.00	-8.71
G	-4.62	-7.37
H	-7.82	-3.81
J	-8.66	+0.91
K	-6.88	+5.36
L	-3.00	+8.18
M	0.00	+4.45
N	+3.91	+1.57
P	+2.39	-3.10
R	-2.39	-3.10
S	-3.91	+1.57

41

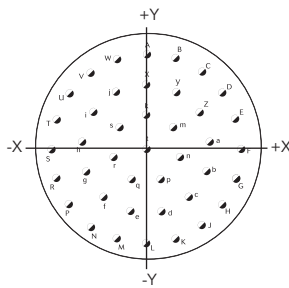

Ctc	X	Y
A	0.00	+10.60
B	+3.28	+10.09

Ctc	X	Y
C	+6.23	+8.58
D	+8.58	+6.23
E	+10.09	+3.28
F	+10.60	0.00
G	+10.09	-3.28
H	+8.58	-6.23
J	+6.23	-8.58
K	+3.28	-10.09
L	0.00	-10.60
M	-3.26	-10.09
N	-6.23	-8.58
P	-8.58	-6.23
R	-10.09	-3.28

Ctc	X	Y
S	-10.60	0.00
T	-10.09	+3.28
U	-8.58	+6.23
V	-6.23	+8.58
W	-3.28	+10.09
X	0.00	+7.20
Y	+3.35	+6.38
Z	+5.92	+4.09
a	+7.15	+0.87
b	+6.73	-2.55
c	+4.78	-5.39
d	+1.73	-6.99
e	-1.73	-6.99

Ctc	X	Y
f	-4.78	-5.39
g	-6.73	-2.55
h	-7.15	+0.87
i	-5.92	+4.09
j	-3.35	+6.38
k	0.00	+3.81
m	+2.98	+2.38
n	+3.71	-0.85
p	-1.66	-3.43
q	+1.66	-3.43
r	-3.71	-0.85
s	-2.98	+2.38
t	0.00	0.00

22

35

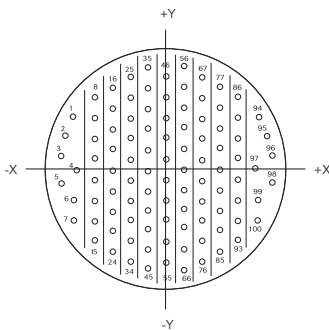

Ctc	X	Y	Ctc	X	Y
1	-10.87	6.12	6	-10.87	3.61
2	-11.86	3.91	7	-10.87	-6.02
3	-12.40	1.55	8	-8.43	8.46
4	-10.54	0.00	9	-8.43	6.05
5	-12.40	-1.55	10	-8.43	3.63

Ctc	X	Y	Ctc	X	Y
11	-8.43	1.22	29	-4.22	1.22
12	-8.43	-1.19	30	-4.22	-1.19
13	-8.43	-3.61	31	-4.22	-3.61
14	-8.43	-6.02	32	-4.22	-6.02
15	-8.43	-8.43	33	-4.22	-8.43
16	-6.32	9.65	34	-4.22	-10.85
17	-6.32	7.24	35	-2.11	12.06
18	-6.32	4.83	36	-2.11	-9.65
19	-6.32	2.41	37	-2.11	7.24
20	-6.32	0.00	38	-2.11	4.83
21	-6.32	-2.41	39	-2.11	-2.41
22	-6.32	-4.83	40	-2.11	0.00
23	-6.32	-7.24	41	-2.11	-2.41
24	-6.32	-9.65	42	-2.11	-4.83
25	-4.22	10.87	43	-2.11	-7.24
26	-4.22	8.46	44	-2.11	-9.65
27	-4.22	6.05	45	-2.11	-12.06
28	-4.22	3.63	46	0.00	10.87

Ctc	X	Y	Ctc	X	Y
47	0.00	8.46	65	2.11	-9.65
48	0.00	6.05	66	2.11	-12.06
49	0.00	3.63	67	4.22	10.87
50	0.00	1.22	68	4.22	8.46
51	0.00	-1.19	69	4.22	6.05
52	0.00	-3.61	70	4.22	3.63
53	0.00	-6.02	71	4.22	1.22
54	0.00	-8.43	72	4.22	-1.19
55	0.00	-10.85	73	4.22	-3.61
56	2.11	12.06	74	4.22	-6.02
57	2.11	9.65	75	4.22	-8.43
58	2.11	7.24	76	4.22	-10.85
59	2.11	4.83	77	6.32	9.65
60	2.11	2.41	78	6.32	7.24
61	2.11	0.00	79	6.32	4.83
62	2.11	-2.41	80	6.32	2.41
63	2.11	-4.83	81	6.32	0.00
64	2.11	-7.24	82	6.32	-2.41

Ctc	X	Y	Ctc	X	Y
83	6.32	-4.83			
84	6.32	-7.24			
85	6.32	-9.65			
86	8.43	8.46			
87	8.43	6.05			
88	8.43	3.63			
89	8.43	1.22			
90	8.43	-1.19			
91	8.43	-3.61			
92	8.43	-6.02			
93	8.43	-8.43			
94	10.87	6.12			
95	11.86	3.91			
96	12.40	1.55			
97	10.54	0.00			
98	12.40	-1.55			
99	10.87	-3.61			
100	10.87	-6.02			

Ctc	X	Y	Ctc	X	Y
83	6.32	-4.83			
84	6.32	-7.24			
85	6.32	-9.65			
86	8.43	8.46			
87	8.43	6.05			
88	8.43	3.63			
89	8.43	1.22			
90	8.43	-1.19			
91	8.43	-3.61			
92	8.43	-6.02			
93	8.43	-8.43			
94	10.87	6.12			
95	11.86	3.91			
96	12.40	1.55			
97	10.54	0.00			
98	12.40	-1.55			
99	10.87	-3.61			
100	10.87	-6.02			

Ctc	X	Y	Ctc	X	Y
83	6.32	-4.83			
84	6.32	-7.24			
85	6.32	-9.65			
86	8.43	8.46			
87	8.43	6.05			
88	8.43	3.63			
89	8.43	1.22			
90	8.43	-1.19			
91	8.43	-3.61			
92	8.43	-6.02			
93	8.43	-8.43			
94	10.87	6.12			
95	11.86	3.91			
96	12.40	1.55			
97	10.54	0.00			
98	12.40	-1.55			
99	10.87	-3.61			
100	10.87	-6.02			

55

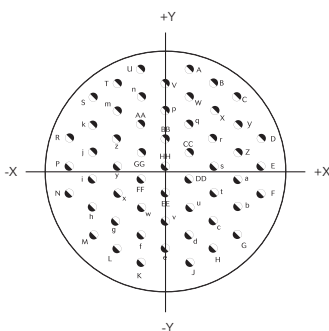

Ctc	X	Y	Ctc	X	Y
A	2.84	11.56	M	-8.53	-8.26
B	5.72	9.91	N	-11.43	-3.30
C	8.53	8.26	P	-11.43	0.00
D	11.43	3.30	R	-11.43	3.30
E	11.43	0.00	S	-8.53	8.26
F	11.43	-3.30	T	-5.72	9.91
G	8.53	-8.26	U	-2.84	11.56
H	5.72	-9.91	V	0.00	9.91
J	2.84	-11.56	W	2.84	8.26
K	-2.84	-11.56	X	5.72	6.60
L	-5.72	-9.91	Y	8.53	4.95

Ctc	X	Y	Ctc	X	Y
Z	8.53	1.65	k	-8.53	4.95
a	8.53	-1.65	m	-5.72	6.60
b	8.53	-4.95	n	-2.84	8.26
c	5.72	-6.60	p	0.00	6.60
d	2.84	-8.26	q	2.84	4.95
e	0.00	-9.91	r	5.72	3.30
f	-2.84	-8.26	s	5.72	0.00
g	-5.72	-6.60	t	5.72	-3.30
h	-8.53	-4.95	u	2.84	-4.95
i	-8.53	-1.65	v	0.00	-6.60
j	-8.53	1.65	w	-2.84	-4.95

Ctc	X	Y	Ctc	X	Y
Z	8.53	1.65	k	-8.53	4.95
a	8.53	-1.65	m	-5.72	6.60
b	8.53	-4.95	n	-2.84	8.26
c	5.72	-6.60	p	0.00	6.60
d	2.84	-8.26	q	2.84	4.95
e	0.00	-9.91	r	5.72	3.30
f	-2.84	-8.26	s	5.72	0.00
g	-5.72	-6.60	t	5.72	-3.30
h	-8.53	-4.95	u	2.84	-4.95
i	-8.53	-1.65	v	0.00	-6.60
j	-8.53	1.65	w	-2.84	-4.95

Ctc	X	Y	Ctc	X	Y
k	-8.53	4.95	x	-5.72	-3.30
m	-5.72	6.60	y	-5.72	0.00
n	-2.84	8.26	z	-5.72	3.30
p	0.00	6.60	AA	-2.84	4.95
q	2.84	4.95	BB	0.00	3.30
r	5.72	3.30	CC	2.84	1.65
s	5.72	0.00	DD	2.84	-1.65
t	5.72	-3.30	EE	0.00	-3.30
u	2.84	-4.95	FF	-2.84	-1.65
v	0.00	-6.60	GG	-2.84	1.65
w	-2.84	-4.95	HH	0.00	0.00

Ctc	X	Y	Ctc	X	Y
k	-8.53	4.95	x	-5.72	-3.30
m	-5.72	6.60	y	-5.72	0.00
n	-2.84	8.26	z	-5.72	3.30
p	0.00	6.60	AA	-2.84	4.95
q	2.84	4.95	BB	0.00	3.30
r	5.72	3.30	CC	2.84	1.65
s	5.72	0.00	DD	2.84	-1.65
t	5.72	-3.30	EE	0.00	-3.30
u	2.84	-4.95	FF	-2.84	-1.65
v	0.00	-6.60	GG	-2.84	1.65
w	-2.84	-4.95	HH	0.00	0.00

24

04

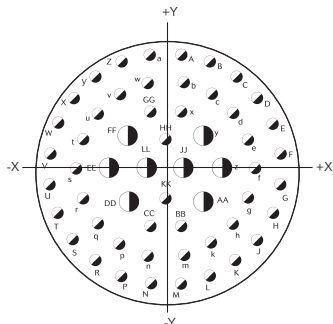

Ctc	X	Y
A	+1.75	+13.49
B	+5.16	+12.57
C	+8.23	+10.80
D	+10.77	+8.28
E	+12.52	+5.21
F	+13.49	+1.75
G	+13.49	-1.75
H	+12.52	-5.21
J	+10.77	-8.28
K	+8.23	-10.80
L	+5.16	-12.57
M	+1.75	-13.49
N	-1.75	-13.49
P	-5.16	-12.57
R	-8.23	-10.80
S	-10.77	-8.28
T	-12.52	-5.21
U	-13.49	-1.75
V	-13.49	+1.75
W	-12.52	+5.21
X	-10.77	+8.28
Y	-8.23	+10.80
Z	-5.16	+12.57

Ctc	X	Y
a	-1.75	+13.49
b	+2.18	+10.08
c	+5.38	+8.78
d	+7.90	+6.38
e	+9.58	+3.35
f	+10.46	0.00
g	+9.58	-3.35
h	+7.90	-6.38
k	+5.38	-8.78
m	+2.18	-10.08
n	-2.18	-10.08

Ctc	X	Y
p	-5.38	-8.78
q	-7.90	-6.38
r	-9.58	-3.35
s	-10.46	0.00
t	-9.58	+3.35
u	-7.90	+6.38
v	-5.38	+8.78
w	-2.18	+10.08
x	+1.75	+6.66
y	+4.37	+3.78
z	+6.55	0.00

Ctc	X	Y
AA	+4.37	-3.78
BB	+1.75	-6.66
CC	-1.75	-6.66
DD	-4.37	-3.78
EE	-6.55	0.00
FF	-4.37	-3.78
GG	-1.75	-6.66
HH	0.00	+3.35
JJ	+2.18	0.00
KK	0.00	-3.35
LL	-2.18	0.00

Ctc	X	Y
AA	+4.37	-3.78
BB	+1.75	-6.66
CC	-1.75	-6.66
DD	-4.37	-3.78
EE	-6.55	0.00
FF	-4.37	-3.78
GG	-1.75	-6.66
HH	0.00	+3.35
JJ	+2.18	0.00
KK	0.00	-3.35
LL	-2.18	0.00

35

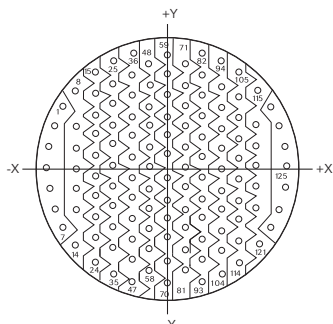

Ctc	X	Y
1	-12.17	+7.09
2	-13.21	+4.83
3	-13.87	+2.41
4	-14.10	0.00
5	-13.87	-2.41
6	-13.21	-4.83
7	-12.17	-7.09
8	-10.77	+9.07
9	-10.54	+4.83
10	-10.54	+2.41
11	-10.54	0.00
12	-10.54	-2.41
13	-10.54	-4.83
14	-10.77	-9.07
15	-8.43	+11.28
16	-8.43	+8.43
17	-8.43	+6.02
18	-8.43	+3.61
19	-8.43	+1.19
20	-8.43	-1.19
21	-8.43	-3.61
22	-8.43	-6.02
23	-8.43	-8.43
24	-8.43	-10.85
25	-6.32	+12.60
26	-6.32	+9.65
27	-6.32	+7.24
28	-6.32	+4.83
29	-6.32	+2.41
30	-6.32	0.00
31	-6.32	-2.41
32	-6.32	-4.83
33	-6.32	-7.24
34	-6.32	-9.65
35	-6.32	-12.07
36	-4.06	+13.49
37	-4.22	+10.85
38	-4.22	+8.43
39	-4.22	+6.02
40	-4.22	+3.61
41	-4.22	+1.19
42	-4.22	-1.19
43	-4.22	-3.61
44	-4.22	-6.02
45	-4.22	-8.43
46	-4.22	-10.85
47	-4.22	-13.26
48	-2.11	+12.07
49	-2.11	+9.65
50	-2.11	+7.24
51	-2.11	+4.83
52	-2.11	+2.41

Ctc	X	Y
53	-2.11	0.00
54	-2.11	-2.41
55	-2.11	-4.83
56	-2.11	-7.24
57	-2.11	-9.65
58	-2.11	-12.07
59	0.00	+13.26
60	0.00	+10.85
61	0.00	+8.43
62	0.00	+6.02
63	0.00	+3.61
64	0.00	+1.19
65	0.00	-1.19
66	0.00	-3.61
67	0.00	-6.02
68	0.00	-8.43
69	0.00	-10.85
70	0.00	-14.10
71	+2.11	+12.07
72	+2.11	+9.65
73	+2.11	+7.24
74	+2.11	+4.83
75	+2.11	+2.41
76	+2.11	0.00
77	+2.11	-2.41
78	+2.11	-4.83

Ctc	X	Y
79	+2.11	-7.24
80	+2.11	-9.65
81	+2.11	-12.07
82	+4.06	+13.49
83	+4.22	+10.85
84	+4.22	+8.43
85	+4.22	+6.02
86	+4.22	+3.61
87	+4.22	+1.19
88	+4.22	-1.19
89	+4.22	-3.61
90	+4.22	-6.02
91	+4.22	-8.43
92	+4.22	-10.85
93	+4.22	-13.26
94	+6.32	+12.60
95	+6.32	+9.65
96	+6.32	+7.24
97	+6.32	+4.83
98	+6.32	+2.41
99	+6.32	0.00
100	+6.32	-2.41
101	+6.32	-4.83
102	+6.32	-7.24
103	+6.32	-9.65

Ctc	X	Y
79	+2.11	-7.24
80	+2.11	-9.65
81	+2.11	-12.07
82	+4.06	+13.49
83	+4.22	+10.85
84	+4.22	+8.43
85	+4.22	+6.02
86	+4.22	+3.61
87	+4.22	+1.19
88	+4.22	-1.19
89	+4.22	-3.61
90	+4.22	-6.02
91	+4.22	-8.43
92	+4.22	-10.85
93	+4.22	-13.26
94	+6.32	+12.60
95	+6.32	+9.65
96	+6.32	+7.24
97	+6.32	+4.83
98	+6.32	+2.41
99	+6.32	0.00
100	+6.32	-2.41
101	+6.32	-4.83
102	+6.32	-7.24
103	+6.32	-9.65

Ctc	X	Y
104	+6.32	-12.07
105	+8.43	+11.28
106	+8.43	+8.43
107	+8.43	+6.02
108	+8.43	+3.61
109	+8.43	+1.19
110	+8.43	-1.19
111	+8.43	-3.61
112	+8.43	-6.02
113	+8.43	-8.43
114	+8.43	-10.85
115	+10.77	+9.07
116	+10.54	+4.83
117	+10.54	+2.41
118	+10.54	0.00
119	+10.54	-2.41
120	+10.54	-4.83
121	+10.77	-9.07
122	+12.17	+7.09
123	+13.21	+4.83
124	+13.87	+2.41
125	+14.10	0.00
126	+13.87	-2.41
127	+13.21	-4.83
128	+12.17	-7.09

For further information contact us at technical.emear@souriau.com (Europe - Asia - Africa)
technical.americas@souriau.com (North America)
 or visit our web site www.souriau.com